

*Other Laboratory glassware
Anderes Laborglas
Autre verre laboratoire
Otro vidrio para Laboratorio*



BOHEMIA *Cristal*

Bottles reagent, narrow mouth, ground-in flat stopper

Enghalsflaschen, mit eingeschliffenem Stopfen

Flacons étroite ouverture, bouchés à l' émeri

Frascos de boca estrecha, tapon con esmerilado

Code	Capacity ml	d mm	h mm	SJ	Packing quantity
clear - Cat. No. 2002/B III. HYDROL. CLASS					
414 102 050	50	41.5	77	14.5/15	48
414 102 100	100	51.5	103	14.5/23	70
414 102 250	250	69	131	19/26	30
414 102 500	500	85	163	24/29	15
414 102 940	1000	106.5	199	29/32	12
414 102 950	2000	132	245	29/32	6
brown - Cat. No. 2002/H III. HYDROL. CLASS					
414 202 050	50	41.5	77	14.5/15	48
414 202 100	100	51.5	103	14.5/23	70
414 202 250	250	69	131	19/26	30
414 202 500	500	85	163	24/29	15
414 202 940	1000	106.5	199	29/32	12
414 202 950	2000	132	245	29/32	6
clear - Cat. No. 2002/B SIMAX					
414 142 956	5000	181	325	45/40	3
414 142 966	10000	227	403	60/46	1

Cat. No. 2002/B
Cat. No. 2002/H

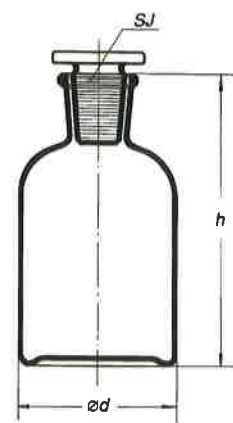

Bottles reagent, wide mouth, ground-in flat stopper

Weithalsflaschen, mit eingeschliffenem Stopfen

Poudriers large ouverture, bouchés à l' émeri

Frascos de boca ancha, tapon con esmerilado

Code	Capacity ml	d mm	h mm	SJ	Packing quantity
clear - Cat. No. 2006/B III. HYDROL. CLASS					
414 104 050	50	41.5	76	24/20	40
414 104 100	100	51.5	95	29/22	48
414 104 250	250	69	128	34.5/24	30
414 104 500	500	85	162	45/27	15
414 104 940	1000	106.5	187	60/31	12
414 104 950	2000	132	238	60/31	6
brown - Cat. No. 2006/H III. HYDROL. CLASS					
414 204 050	50	41.5	76	24/20	40
414 204 100	100	51.5	95	29/22	48
414 204 250	250	69	128	34.5/24	30
414 204 500	500	85	162	45/27	15
414 204 940	1000	106.5	187	60/31	12
414 204 950	2000	132	238	60/31	6
clear - Cat. No. 2006/B SIMAX					
414 144 956	5000	181	338	85/55	3
414 144 966	10000	227	408	85/55	1

Cat. No. 2006/B
Cat. No. 2006/H

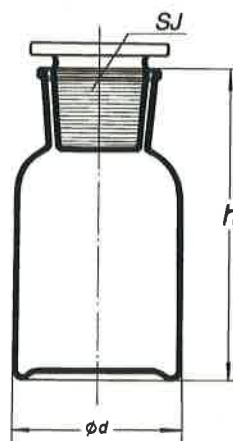

Bottles dropping, ground-in flat stopper

Tropfengläser TK, mit eingeschliffenem Deckelstopfen

Flacons compte - gouttes TK, bouchés à l' émeri, bouchon plat

Frascos goteros ("cuentagotas")

Code	Capacity ml	d mm	h mm	SJ	Packing quantity
clear - Cat. No. 2020/B III. HYDROL. CLASS					
414 109 050	50	44	92	14.5/23	96
414 109 100	100	55	106	14.5/23	70
brown - Cat. No. 2020/H III. HYDROL. CLASS					
414 209 050	50	44	92	14.5/23	96
414 209 100	100	55	106	14.5/23	70

Cat. No. 2020/B
Cat. No. 2020/H

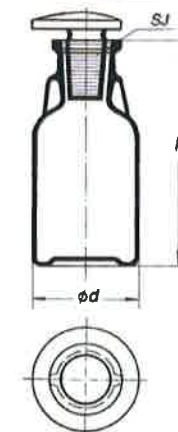

Bottles reagent, narrow mouth, without ground-in flat stopper

Enghals - Steilbrustflaschen NS, ohne eingeschlifffenen Stopfen

Flacons étroite ouvertei, sans bouchés à l' émeri

Fascos de boca estrecha, sin tapón con esmerilado

Cat. No. 2013/B
Cat. No. 2013/H

Code	Capacity ml	d mm	h mm	SJ	Packing quantity
clear - Cat. No. 2009/B III. HYDROL. CLASS					
414 123 050	50	41.5	77	14.5/15	48
414 123 100	100	51.5	103	14.5/23	48
414 123 250	250	69	131	19/26	30
414 123 500	500	85	163	24/29	15
414 123 940	1000	106.5	199	29/32	12
414 123 950	2000	133	245	29/32	6
brown - Cat. No. 2009/H III. HYDROL. CLASS					
414 223 050	50	41.5	77	14.5/15	48
414 223 100	100	51.5	103	14.5/23	48
414 223 250	250	69	131	19/26	30
414 223 500	500	85	163	24/29	15
414 223 940	1000	106.5	199	29/32	12
414 223 950	2000	133	24	29/32	6

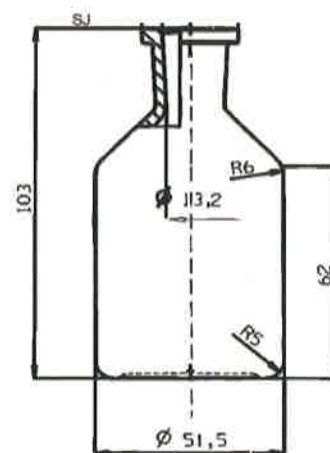

Bottles reagent, wide mouth, without ground-in flat stopper

Weithals - Steilbrustflaschen NS, ohne eingeschlifffenen Stopfen

Poudriers large ouverture, sans bouchés à l' émeri

Fascos de boca ancha, sin tapón con esmerilado

Cat. No. 2013/B
Cat. No. 2013/H

Code	Capacity ml	d mm	h mm	SJ	Packing quantity
clear - Cat. No. 2013/B III. HYDROL. CLASS					
414 125 050	50	41.5	76	24/20	48
414 125 100	100	51.5	95	29/22	48
414 125 250	250	69	128	34.5/40	30
414 125 500	500	85	162	45/27	15
414 125 940	1000	106.5	197	60/46	12
414 125 950	2000	133	238	60/46	6
brown - Cat. No. 2013/H III. HYDROL. CLASS					
414 225 050	50	41.5	76	24/20	48
414 225 100	100	51.5	95	29/22	48
414 225 250	250	69	128	34.5/40	30
414 225 500	500	85	162	45/40	15
414 225 940	1000	106.5	197	60/46	12
414 225 950	2000	133	238	60/46	6

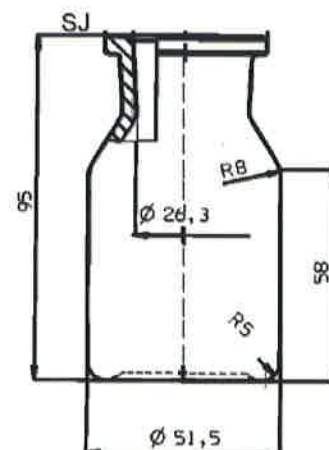

Bürettenflasche

Bürettenflasche

Cat. No. 2100/H

Code	Capacity ml	d mm	h mm	SJ	Packing quantity
clear - Cat. No. 2100/B III. HYDROL. CLASS					
436 801 0461	2000	160	200	29/32	6
brown - Cat. No. 2100/H III. HYDROL. CLASS					
436 802 046	2000	160	200	29/32	6

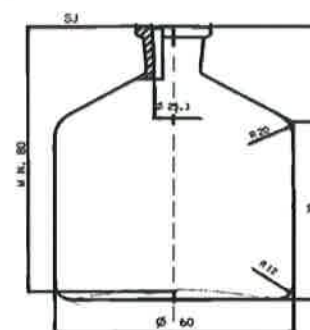

Bottles reagent, narrow mouth, ground-in flat stopper, standard shape

Enghals - Steilbrustflaschen mit eingeschliffenem Stopfen, typisierte Form

Poudriers large ouverture, bouchés à l' émeri, forme normalisée à égaliment aigu

Frascos de boca ancha, tapón con esmerilado, forma tipificada

Code	Capacity ml	d mm	h mm	SJ	Packing quantity
clear - Cat. No. 2010/B III. HYDROL. CLASS					
414 126 050	50	41.5	77	14.5/15	48
414 126 100	100	51.5	103	14.5/23	48
414 126 250	250	69	131	19/26	30
414 126 500	500	85	163	24/29	15
414 126 940	1000	106.5	199	29/32	12
414 126 950	2000	133	245	29/32	6
brown - Cat. No. 2010/H III. HYDROL. CLASS					
414 226 050	50	41.5	77	14.5/15	48
414 226 100	100	51.5	103	14.5/23	48
414 226 250	250	69	131	19/26	30
414 226 500	500	85	163	24/29	15
414 226 940	1000	106.5	199	29/32	12
414 226 950	2000	133	245	29/32	6

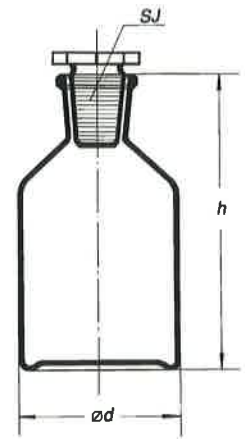

Cat. No. 2010/B
Cat. No. 2010/H

Bottles reagent, wide mouth, ground-in flat stopper, standard shape

Weithals - Steilbrustflaschen mit eingeschliffenem Stopfen, typisierte Form

Poudriers large ouverture, bouchés à l' émeri, forme normalisée à égaliment aigu

Frascos de boca ancha, tapón con esmerilado, forma tipificada

Code	Capacity ml	d mm	h mm	SJ	Packing quantity
clear - Cat. No. 2014/B III. HYDROL. CLASS					
414 127 050	50	41.5	76	24/20	48
414 127 100	100	51.5	95	29/22	48
414 127 250	250	69	128	34.5/24	30
414 127 500	500	85	162	45/27	15
414 127 940	1000	106.5	197	60/46	12
414 127 950	2000	133	238	60/46	6
brown - Cat. No. 2014/H III. HYDROL. CLASS					
414 227 050	50	41.5	76	24/20	48
414 227 100	100	51.5	95	29/22	48
414 227 250	250	69	128	34.5/24	30
414 227 500	500	85	162	45/27	15
414 227 940	1000	106.5	197	60/46	12
414 227 950	2000	133	238	60/46	6

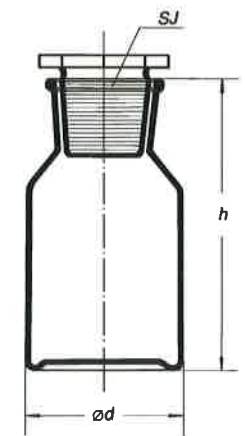

Cat. No. 2014/B
Cat. No. 2014/H

Bottles square type, with SJ stopper, wide mouth

Vierkantenflaschen mit NS Stopfen, weithalsig

Flacons quadrilaterals, large ouverture, bouchés à l' émeri CS

Frascos cuatragonales boca ancha, tapón esmerilado

Code	Capacity ml	A mm	B mm	h mm	SJ	Packing quantity
clear - Cat. No. 2043/B						
414 112 100	100	51	51	103	29/22	48
414 112 150	150	70.5	51.5	103	29/22	18
414 112 250	250	70	50	143	29/22	42
414 112 350	350	71.5	71.5	153	34.5/24	30
414 112 500	500	92	71.5	148	34.5/24	24
414 112 750	750	90	71.5	237	45/27	15
brown - Cat. No. 2043/H						
414 212 100	100	51	51	103	29/22	
414 212 150	150	70.5	51.5	103	29/22	
414 212 250	250	70	50	143	29/22	
414 212 350	350	71.5	71.5	153	34.5/24	
414 212 500	500	92	71.5	148	34.5/24	
414 212 750	750	90	71.5	237	45/27	

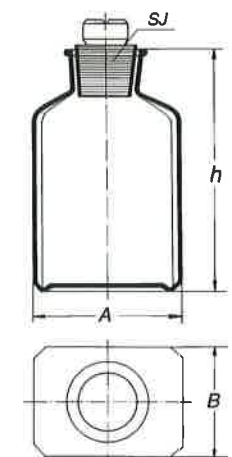

Cat. No. 2043/B
Cat. No. 2043/H

**Bottles reagent, narrow mouth,
ground-in flat stopper,
standard shape**

Enghals - Steilbrustflaschen NS mit
Stopfen, Poly PEHD Natur, typisierte
Form
Flacons étroite ouverture, bouchés à
l' émeri, forme normalisée
Frascos de boca estrecha, tapón
con esmerilado, forma tipificada

**Cat. No. 2010/B-KS
Cat. No. 2010/H-KS**

Code	Capacity ml	d mm	h mm	SJ	Packing quantity
clear - Cat. No. 2010/B III. HYDROL. CLASS					
414 126 050 P	50	41.5	77	14.5/15	48
414 126 100 P	100	51.5	103	14.5/23	48
414 126 250 P	250	69	131	19/26	30
414 126 500 P	500	85	163	24/29	15
414 126 940 P	1000	106.5	199	29/32	12
414 126 950 P	2000	133	245	29/32	6
brown - Cat. No. 2010/H III. HYDROL. CLASS					
414 226 050 P	50	41.5	77	14.5/15	48
414 226 100 P	100	51.5	103	14.5/23	48
414 226 250 P	250	69	131	19/26	30
414 226 500 P	500	85	163	24/29	15
414 226 940 P	1000	106.5	199	29/32	12
414 226 950 P	2000	133	245	29/32	6

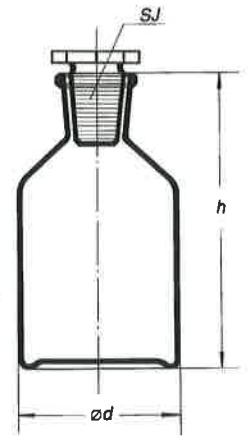

**Bottles reagent, wide mouth,
ground-in flat stopper,
standard shape**

Weithals - Steilbrustflaschen NS mit
Stopfen, Poly PEHD Natur, typisierte
Form
Poudriers, large ouverture, bouchés à
l' émeri, forme normalisée à
épaulement aigu
Frascos de boca ancha, tapón
con esmerilado, forma tipificada

**Cat. No. 2014/B-KS
Cat. No. 2014/H-KS**

Code	Capacity ml	d mm	h mm	SJ	Packing quantity
clear - Cat. No. 2014/B III. HYDROL. CLASS					
414 127 050 P	50	41.5	76	24/20	48
414 127 100 P	100	51.5	95	29/22	48
414 127 250 P	250	69	128	34.5/24	30
414 127 500 P	500	85	162	45/27	15
414 127 940 P	1000	106.5	197	60/46	12
414 127 950 P	2000	133	238	60/46	6
brown - Cat. No. 2014/H III. HYDROL. CLASS					
414 227 050 P	50	41.5	76	24/20	48
414 227 100 P	100	51.5	95	29/22	48
414 227 250 P	250	69	128	34.5/24	30
414 227 500 P	500	85	162	45/27	15
414 227 940 P	1000	106.5	197	60/46	12
414 227 950 P	2000	133	238	29/32	6

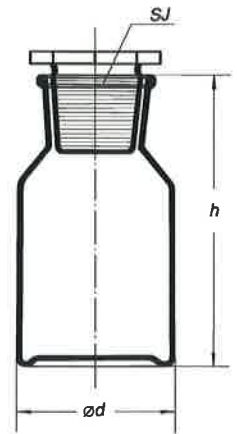

Gewindeflasche

Weithaltsflasche

Cat. No. 2200/H

Code	Capacity ml	d mm	h mm	Packing quantity	weight	Packs/Pallet	Packs/layer
414 402 085	75	48	79	48	4,5	112	8
414 302 300	300	69,5	131,5	30	8	35	5
414 302 800	800	89,5	188,5	15	8	35	5
414 301 300	1300	118	185	12	9	30	5

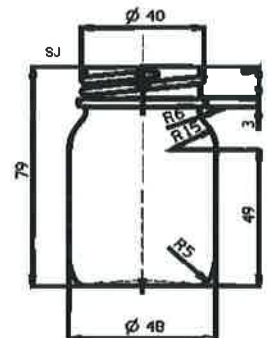

**Gewindeflasche,
rechteckig**

rechteckig

Cat. No. 2250/H

Code	Capacity ml	A mm	B mm	h mm	Packing quantity	weight	Packs/Pallet	Packs/layer
414 302 250	250	70	50	145	30	9	35	5

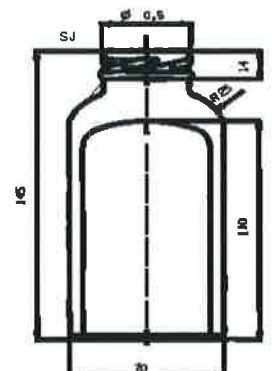
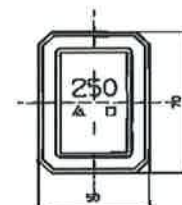

Dishes Petri ANUMBRA

Petrischalen ANUMBRA

Boîtes de Pétri ANUMBRA

Cajas de Petri ANUMBRA

Code	d mm	h mm	Thickness mm	Packing quantity
492 002 040	40	12	1.35	144
492 002 050	50	12	1.8	144
492 002 060	60	12	1.8	144
492 003 060	60	15	1.8	144
492 003 070	70	15	1.8	144
492 003 080	80	15	1.8	144
492 003 090	90	15	1.8	72
Cat. No. 2290/I				
492 001 100	100	10	1.8	72
492 003 100	100	15	1.8	72
492 004 100	100	20	1.8	72
492 004 120	120	20	1.8	72
492 005 150	150	25	1.8	36
492 006 180	180	30	2.0	9
492 006 200	200	30	2.0	6
492 008 200	200	50	2.0	7

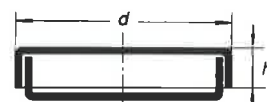

Watch glasses, flamed edges

Uhrgläser, Ränder abgeflammt

Verres de montre, bords rebûs

Vidrios de reloj, borde guemado

Code 634	Diameter mm	Thickness mm	Packing quantity
952 430 780	40	1.6	50
952 430 790	50	1.6	50
952 430 840	60	1.6	50
952 430 860	70	1.8	50
952 430 910	80	1.8	50
952 430 950	90	1.8	50
952 430 010	100	1.8	50
952 430 060	110	1.8	50
952 430 070	120	1.8	50
952 430 080	125	1.8	50
952 430 110	140	1.8	50
952 430 115	145	1.8	50
952 430 120	150	1.8	50
952 430 130	160	1.8	50
952 430 140	175	1.8	50
7330 0001 20001	200	2.0	10
7330 0001 25001	250	2.0	10
7330 0001 30001	300	2.0	10



Cat. No. 170/II

Glass beads

Glasperlen poliert für Rührwerks-
mühlen, Filteranlagen, Oberflächen-
verarbeitung

Glass beads for industrial and
decorative application

Code 632	Abmessung mm	ca. Stückzahl pro 1 kg	Verpackung kg Säcke / UK 25 Beutel 1kg
645 001 015	1,5 +/- 0,2	226.354	25 1
645 001 020	2,0 +/- 0,2	95.493	25 1
645 001 025	2,5 +/- 0,2	48.893	25 1
645 001 030	3,0 +/- 0,2	28.294	25 1
645 001 035	3,5 +/- 0,3	17.818	25 1
645 001 040	4,0 +/- 0,3	11.937	25 1
645 001 045	4,5 +/- 0,3	8.384	25 1
645 001 050	5,0 +/- 0,3	6.112	25 1
645 001 060	6,0 +/- 0,3	3.537	25 1
645 001 070	7,0 +/- 0,3	2.227	25 1
645 001 080	8,0 +/- 0,4	1.492	25 1
645 001 090	9,0 +/- 0,4	1.048	25 1
645 001 010	10,0 +/- 0,5	764	25 1



Jars staining Hellendahl

Färbekästen Hellendahl mit
Erweiterung

Boîtes á coloration de Hellendahl

Recipientes según Hellendahl

Code 632	Height mm	Length mm	Width mm	Packing quantity
499 890 004	100	58.5	58.5	10

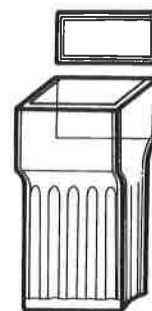

Cat. No. 2954

Jars staining Hellendahl

Färbekästen nach Hellendahl
ohne Erweiterung

Boîtes á coloration de Hellendahl

Recipientes según Hellendahl

Code 632	Height mm	Length mm	Width mm	Packing quantity
499 890 0049	93	92	43	10



Cat. No. 2954

Jars staining Schiefferdecker

Färbekästen nach Schiefferdecker

Boîtes á coloration de
Schiefferdecker

Recipientes según Schiefferdecker

Code 632	Height mm	Length mm	Width mm	Packing quantity
499 890 001	50	90	70	10

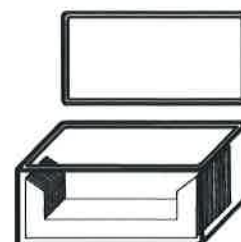

Cat. No. 2956

Jars staining Coplin

Färbekästen nach Coplin

Boîtes á coloration de Coplin

Recipientes según Coplin

Code 632	Diameter	Height mm	Packing quantity
499 890 010	73	115	10



Cat. No. 2959

Jars staining

Färbekästen

Boîtes á coloration

Recipientes

Cat. No. 2960

Code	Height mm	Length mm	Width mm	Packing quantity
632				
499 890 022				
insert				
Färbegestell				
panier				
cestillo				
499 890 025				
bottom part and lid				
Unterteil und Deckel				
cuve avec couvercle (sans panier)				
cubeta con tapa				

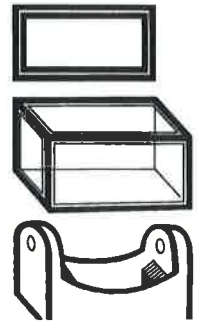

Presses staining dishes with cavity and glass cover plate

Gepresste Mikroskopiernapfe mit Vertiefung und Deckplatte

Godets pour microscopie pressés, avec concavité et plaque couvrante

Platillos para microscopia, prensados con cavidad y lámina de cubrir

Cat. No. 546/40

Code	Height mm	Length mm	Width mm	Packing quantity
632				
517 103 040	15	40	40	10

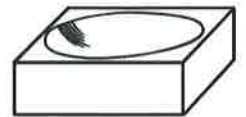

Aquarium Jars

Aquarienkästen, Rand geschliffen
Glasart Sodaglas

Aquarium Jars, ground edge,
material glass soda glass

Code	Height mm	Length mm	Width mm
23 210 111	100	100	100
23 210 113	100	100	150
23 210 115	100	100	200
23 210 122	100	120	120
23 210 225	120	120	200
23 210 313	150	100	150
23 210 369	150	220	300
23 210 449	160	160	300
23 210 424	180	130	180
23 210 535	200	150	200
23 210 647	220	180	250
23 210 769	240	220	300
23 210 869	260	230	360

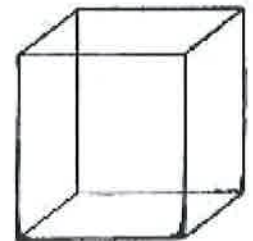

ISO 4798
Funnels plain, angle 60°, short stem

Trichter im Winkel von 60° mit kurzen Stiel, Borosilikat
 Entonnoirs á 60° pour analyses, tige courte
 Embudos con vástago corto, ángulo 60°

Code 632	d1 mm	d2 mm	l mm	Packing quantity
413 001 035	35	6	35	10
413 001 045	45	6	45	10
413 001 055	55	8	55	10
413 001 075	75	8	75	10
413 001 085*	85	9	85	10
413 001 100	100	10	100	10
413 001 125	125	16	125	6
413 001 150	150	16	150	6
413 001 200	200	24	150	6
413 001 250	250	30	175	2
413 001 300	300	34	175	2

* This size is out of norm ISO, DIN.
 * Diese Masse sind ausser Norm ISO, DIN.
 * Cette dimension n' est pas normalisée ISO, DIN.
 * Esta dimensión no está normalizada ISO, DIN.

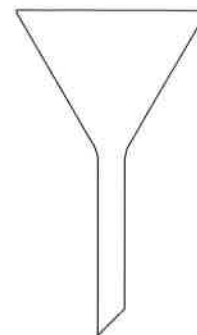
**Cat. No. 2350
BOROSILIKAT**

ISO 4798
Funnels plain, angle 60°, short stem

Trichter im Winkel von 60° mit kurzen Stiel, Kalk Soda Glas
 Entonnoirs á 60° pour analyses, tige courte
 Embudos con vástago corto, ángulo 60°

Code 632	d1 mm	d2 mm	l mm	Packing quantity
N413 001 035	35	6	35	10
N413 001 045	45	6	45	10
N413 001 055	55	8	55	10
N413 001 075	75	8	75	10
N413 001 100	100	10	100	10
N413 001 125	125	16	125	6
N413 001 150	150	16	150	6
N413 001 200	200	24	150	6
N413 001 250	250	30	175	2
N413 001 300	300	34	175	2

**Cat. No. 2350 SO
KALK-SODA**
